

Достроить вид сверху для заданной пирамиды. Построить вид слева. Выполнить разрезы.
(Черновик и чистовик на формате А3).

5

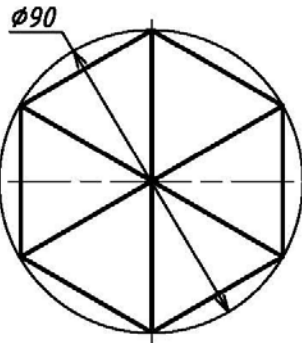

6

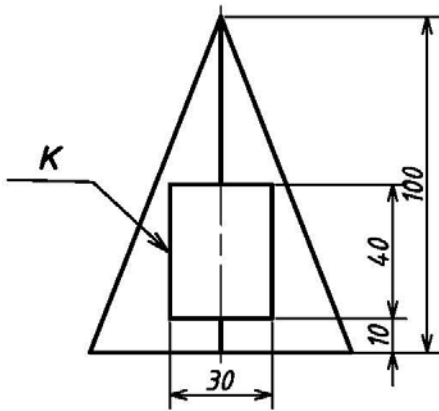
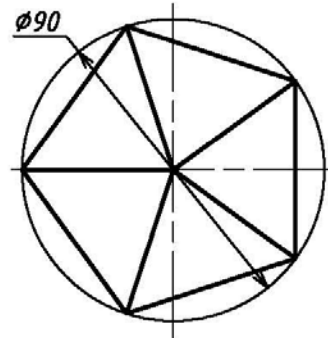
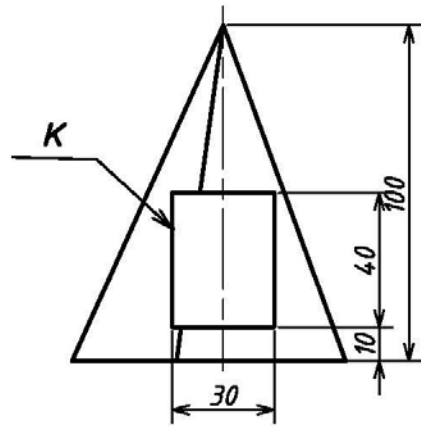

7

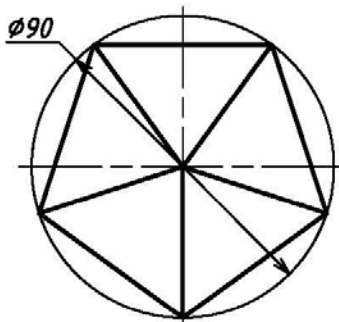
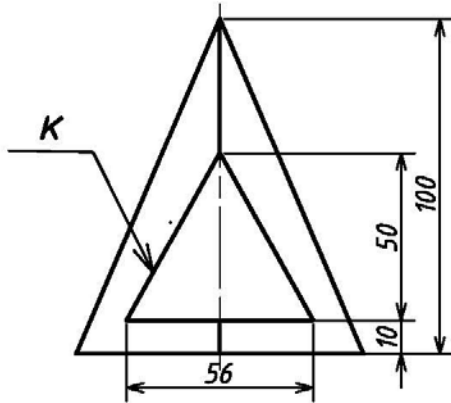

8

